



Pursuing
The Precision
Serving
The World

D01

03
05
07
09
11
13
15
17
19
21
23
25

带表卡规

Dial Caliper Gauge

D

公制带表内卡规

Metric Inside Dial Caliper Gauges

公制带表外卡规

Metric Outside Dial Caliper Gauges

英制带表内卡规

Inch Inside Dial Caliper Gauges

英制带表外卡规

Inch Outside Dial Caliper Gauges



带表卡规 DIAL CALIPER GAUGES

D02

04
06
08
10
12
14
16
18
20
22
24
26

带表内卡规主要用于工件内径，环形槽底及台阶孔径等的测量，可完成其它量具无法完成的特形孔的测量。

The inside dial caliper gauges are attachment to the dial indicator and used for measuring inside diameter, ring groove bottom diameter and inside step diameter or holes of the workpieces.



带表外卡规主要用于工件外径，环形槽底外径工件特殊部位厚度等的测量，可完成其它量具无法完成的特形零件的测量。

The outside dial caliper gauges are attachment to the dial indicator and used for measurement of outside diameters, ring groove bottom diameter, narrow grooves and hard to reach dimensions.



带表卡规

DIAL CALIPER GAUGES

公制带表内卡规

Metric Inside Dial Caliper Gauges

01

D03

05

07

09

11

13

15

17

19

21

23

25

- 测量范围大于395mm以上的带表内卡规，可根据用户要求特殊加工。
- 测量范围大于95mm以上内卡规配防震百分表
- The inside dial caliper gauges with measuring range over 395mm can be made upon request.
- The inside caliper gauge match with shock-proof dial indicator above 95mm of measuring range.



511-103



511-105

主要技术参数 SPECIFICATIONS

货号 Nr.	型号 Model	分度值 Grad.(mm)	测量范围 Range (mm)	外形尺寸(mm)		
				A	B	L
511-102	NKG10-30	0.01	10-30	2.5	∅1.8	50
511-103	NKG15-35	0.01	15-35	3	∅3	50
511-104	NKG35-55	0.01	35-55	6	∅3	80
511-105	NKG55-75	0.01	55-75	8	∅3	90
511-106	NKG75-95	0.01	75-95	8	∅3	100
511-107	NKG95-115	0.01	95-115	10	∅3.2	150
511-108	NKG115-135	0.01	115-135	10	∅3.2	150
511-109	NKG135-155	0.01	135-155	10	∅3.2	200
511-110	NKG155-175	0.01	155-175	10	∅3.2	200
511-111	NKG175-195	0.01	175-195	10	∅3.2	200
511-112	NKG195-215	0.01	195-215	10	∅3.2	200
511-113	NKG215-235	0.01	215-235	10	∅3.2	200
511-114	NKG235-255	0.01	235-255	10	∅3.2	380
511-115	NKG255-275	0.01	255-275	10	∅3.2	380
511-116	NKG275-295	0.01	275-295	10	∅3.2	380
511-117	NKG295-315	0.01	295-315	10	∅3.2	380
511-118	NKG315-335	0.01	315-335	10	∅3.2	200
511-119	NKG335-355	0.01	335-355	10	∅3.2	200
511-120	NKG355-375	0.01	355-375	10	∅3.2	200
511-121	NKG375-395	0.01	375-395	10	∅3.2	200

外形尺寸图 DIMENSIONS(mm)

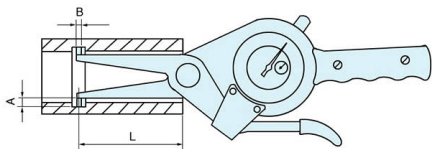

带表卡规

DIAL CALIPER GAUGE

公制带表外卡规

Metric Outside Dial Caliper Gauges

02

D04

06

08

10

12

14

16

18

20

22

24

26

- 测量范围大于260mm以上的带表外卡规，可根据用户要求特殊加工。
- 测量范围大于100mm以上外卡规配防震百分表
- The outside dial caliper gauges with measuring range over 260 mm can be made upon request.
- The outside caliper gauge match with shockproof dial indicator above 100mm of measuring range.

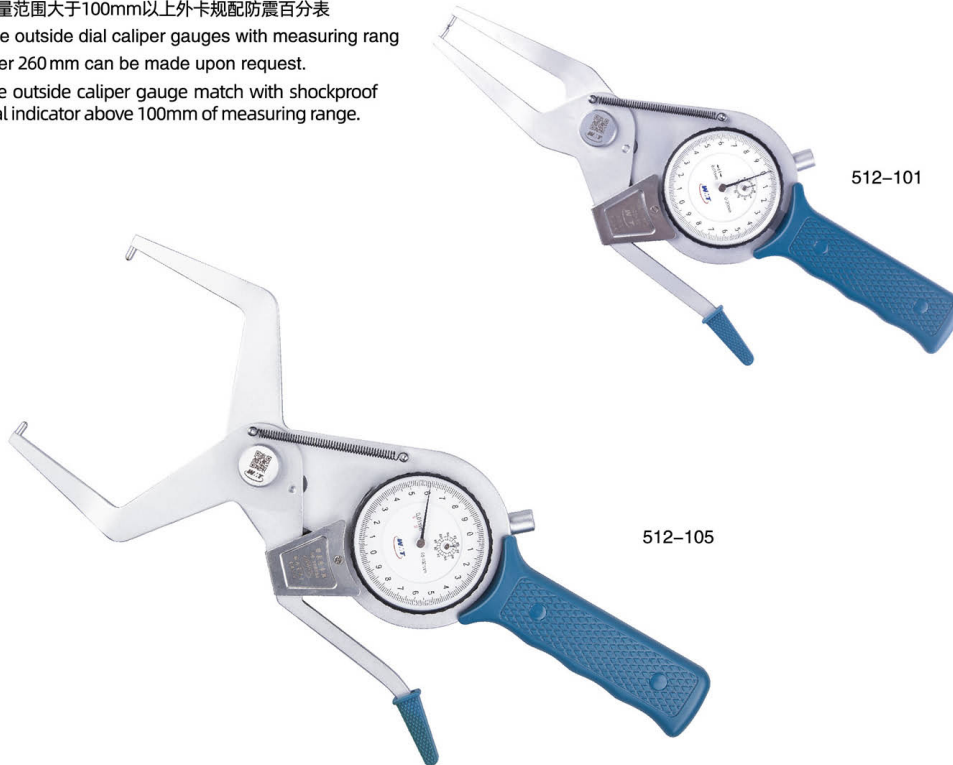

主要技术参数 SPECIFICATIONS

货号 Nr.	型号 Model	分度值 Grad.(mm)	测量范围 Range (mm)	外形尺寸(mm)		
				A	B	L
512-101	WKG0-20	0.01	0-20	6	∅3	60
512-102	WKG20-40	0.01	20-40	6	∅3	60
512-103	WKG40-60	0.01	40-60	6	∅3	55
512-104	WKG60-80	0.01	60-80	6	∅3	55
512-105	WKG80-100	0.01	80-100	6	∅3	55
512-106	WKG100-120	0.01	100-120	10	∅3.2	95
512-107	WKG120-140	0.01	120-140	10	∅3.2	95
512-108	WKG140-160	0.01	140-160	10	∅3.2	95
512-109	WKG160-180	0.01	160-180	10	∅3.2	95
512-110	WKG180-200	0.01	180-200	10	∅3.2	95
512-111	WKG200-220	0.01	200-220	10	∅3.2	120
512-112	WKG220-240	0.01	200-220	10	∅3.2	120
512-113	WKG240-260	0.01	200-220	10	∅3.2	120

外形尺寸图 DIMENSIONS(mm)

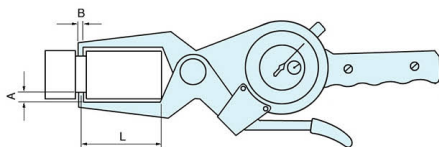



Pursuing
The Precision
Serving
The World

带表卡规 DIAL CALIPER GAUGES

英制带表卡规 Inch Dial Caliper Gauges

01

03

D05

07

09

11

13

主要技术参数 SPECIFICATIONS

货号 Nr.	型号 Model	测量范围 Range (in)	分度值 Grad.(in)	外形尺寸(in)		
				A	B	L
512-201	WKG31	0-0.8	0.0005	0.236	0.118	2.3
512-202	WKG32	0.8-1.6	0.0005	0.236	0.118	2.3
512-203	WKG33	1.6-2.4	0.0005	0.236	0.118	2.1
512-204	WKG34	2.4-3.2	0.0005	0.236	0.118	2.1
512-205	WKG35	3.2-4.0	0.0005	0.236	0.118	2.1
512-301	WKG41	0-0.8	0.001	0.236	0.118	2.3
512-302	WKG42	0.8-1.6	0.001	0.236	0.118	2.3
512-303	WKG43	1.6-2.4	0.001	0.236	0.118	2.1
512-304	WKG44	2.4-3.2	0.001	0.236	0.118	2.1
512-305	WKG45	3.2-4.0	0.001	0.236	0.118	2.1



512-202

外形尺寸图 DIMENSIONS(in)

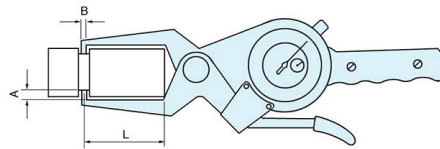

25



511-304

外形尺寸图 DIMENSIONS(in)

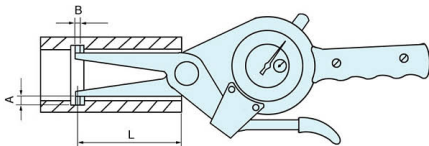

主要技术参数 SPECIFICATIONS

货号 Nr.	型号 Model	测量范围 Range (in)	分度值 Grad.(in)	外形尺寸(in)		
				A	B	L
511-203	NKG11	0.6-1.4	0.0005	0.118	0.118	1.9
511-204	NKG12	1.4-2.2	0.0005	0.236	0.118	3.1
511-205	NKG13	2.2-3.0	0.0005	0.315	0.118	3.1
511-206	NKG14	3.0-3.8	0.0005	0.315	0.118	3.9
511-303	NKG21	0.6-1.4	0.001	0.118	0.118	1.9
511-304	NKG22	1.4-2.2	0.001	0.236	0.118	3.1
511-305	NKG23	2.2-3.0	0.001	0.315	0.118	3.1
511-306	NKG24	3.0-3.8	0.001	0.315	0.118	3.9

带表卡规 DIAL CALIPER GAUGES

大量程带表外卡规 Dial Caliper Gauges

02
04
D06
08
10
12
14
16
18
20
22
24
26



512-401

外形尺寸图 DIMENSIONS(mm)

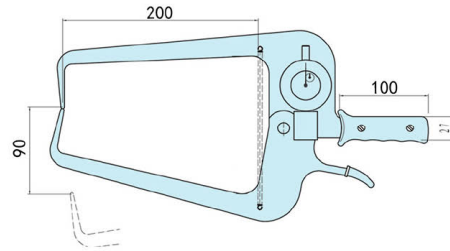

主要技术参数 SPECIFICATIONS

货号 Nr.	型号 Model	分度值 Grad.(mm)	测量范围 Range(mm)
512-401	WKG0-90	0.1	0-90
512-402	WKG0-80	0.1	0-80
512-501	WKG0-50	0.05	0-50

外形尺寸图 DIMENSIONS(mm)

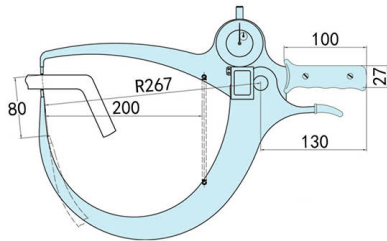

512-402





大测深带表内卡规

DIAL CALIPER GAUGES

01

03

05

D07

09

11

13

15

17

19

21

23

25

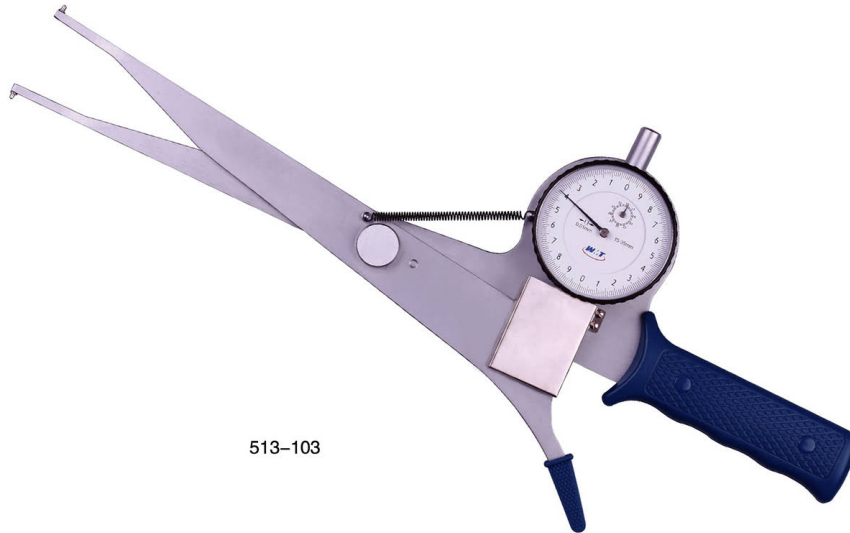

513-103

主要技术参数 SPECIFICATIONS

货号 Nr.	型号 Model	分度值 Grad.(mm)	测量范围 Range(mm)	外形尺寸				
				A	B	L		
513-103	NKG15-35	0.01	15-35	3	Φ3	160	200	250
513-104	NKG35-55	0.01	35-55	13	Φ3	160	250	200
513-105	NKG55-75	0.01	55-75	8	Φ3	200	250	

外形尺寸图 DIMENSIONS(mm)

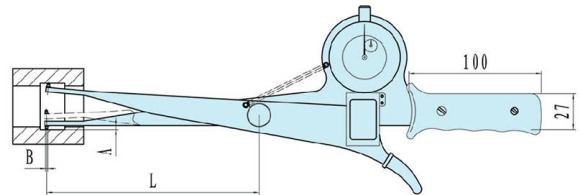

快速卡规

External Quick Caliper



514-101

主要技术参数 SPECIFICATIONS

货号 Nr.	型号 Model	分度值 Grad.(mm)	测量范围 Range(mm)
514-101	WKG0-10	0.1	10

外形尺寸图 DIMENSIONS(mm)

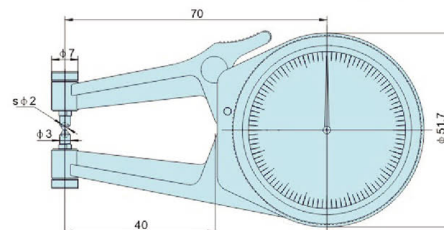

带可换测头的高精度内卡规
DIAL CALIPER GAUGES WITH REPLACEABLE ANVILS

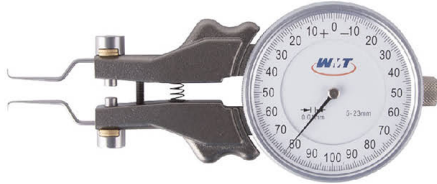

515-102

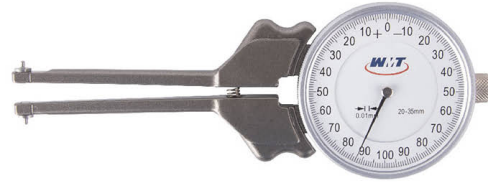

515-103



515-105

外形尺寸图 DIMENSIONS(mm)

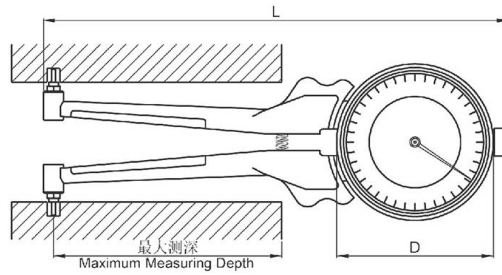

主要技术参数 SPECIFICATIONS

货号 Nr.	型号 Model	分度值 Grad.(mm)	测量范围 Range(mm)	精度指标 Accuracy(mm)	测量深度 Measuring depth(mm)	可换测头 Anvils(pair)	外形尺寸 L D
515-102	NKG5-23	0.01	5-23	0.02	20	3	150 Φ62
515-103	NKG20-35	0.01	20-35	0.02	70	7	168 Φ62
515-104	NKG30-62	0.01	30-62	0.02	75	5	172 Φ62
515-105	NKG55-153	0.01	55-153	0.02	90	6	183 Φ62

附件图 Accessory Figure

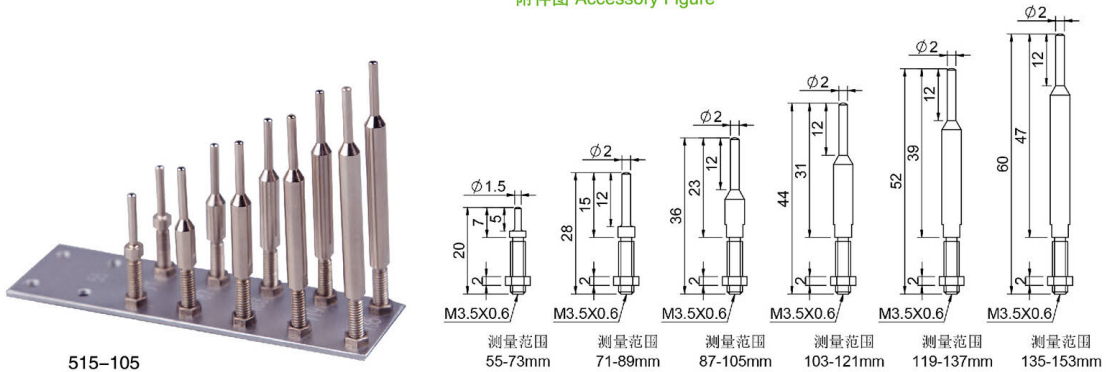

02
04
06
D08
10
12
14
16
18
20
22
24
26